

V _{RSM} V _{RRM}	I _D (T _{case} = 100 °C)	
	110 A	160 A
200 V	SKD 110/02	SKD 160/02
400 V	SKD 110/04	SKD 160/04
800 V	SKD 110/08	SKD 160/08
1200 V	SKD 110/12	SKD 160/12
1400 V	SKD 110/14	SKD 160/14
1600 V	SKD 110/16	SKD 160/16
1800 V	SKD 110/18*	SKD 160/18*

SEMIPONT® 4 Power Bridge Rectifiers

SKD 110
SKD 160



Symbol	Conditions	SKD 110	SKD 160	Units
I _D	T _{case} = 100 °C	110	160	A
	T _{amb} = 45 °C, chassis ¹⁾ P1/200	28	30	A
		70	75	A
	T _{amb} = 35 °C, P1/120 F P3/120 F	110	145	A
123		146	A	
I _{FSM}	T _{vj} = 25 °C, 10 ms	1200	1800	A
	T _{vj} = 150 °C, 10 ms	1000	1500	A
i ² t	T _{vj} = 25 °C, 8,3...10 ms	7200	16 200	A ² s
	T _{vj} = 150 °C, 8,3...10 ms	5000	11 200	A ² s
V _F	T _{vj} = 25 °C; I _F = 300 A	1, 9	1,65	V
V _(TO)	T _{vj} = 150 °C	0,85	0,85	V
r _T	T _{vj} = 150 °C	4	3	mΩ
I _{RD}	T _{vj} = 25 °C; V _{RD} = V _{RRM}	0,5	0,5	mA
	T _{vj} = 150 °C; V _{RD} = V _{RRM}	5	6	mA
R _{thjc}	per diode	0,9	0,65	°C/W
	total	0,15	0,11	°C/W
R _{thch}	total	0,03		°C/W
T _{vj}		- 40 ... + 150		°C
T _{stg}		- 40 ... + 125		°C
V _{isol}	a.c. 50...60 Hz; r.m.s.; 1 s / 1 min	3600 / 3000		V~
M ₁	to heatsink	SI units	5 ± 15 %	Nm
		US units	44 ± 15 %	lb. in.
M ₂	to terminals	SI units	5 ± 15 %	Nm
		US units	44 ± 15 %	lb. in.
w		270		g
Case		G 37		

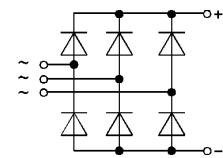

SKD

Features

- Robust plastic case with screw terminals
- Large, isolated base plate
- Blocking voltage to 1800 V
- High surge currents
- Easy chassis mounting
- UL recognized, file no. E 63 532

Typical Applications

- Three phase rectifiers for power supplies
- Input rectifiers for variable frequency drives
- Rectifiers for DC motor field supplies
- Battery charger rectifiers

* Available in limited quantities

¹⁾ Painted metal sheet of minimum 250 x 250 x 1 mm: R_{thca} = 1,8 °C/W

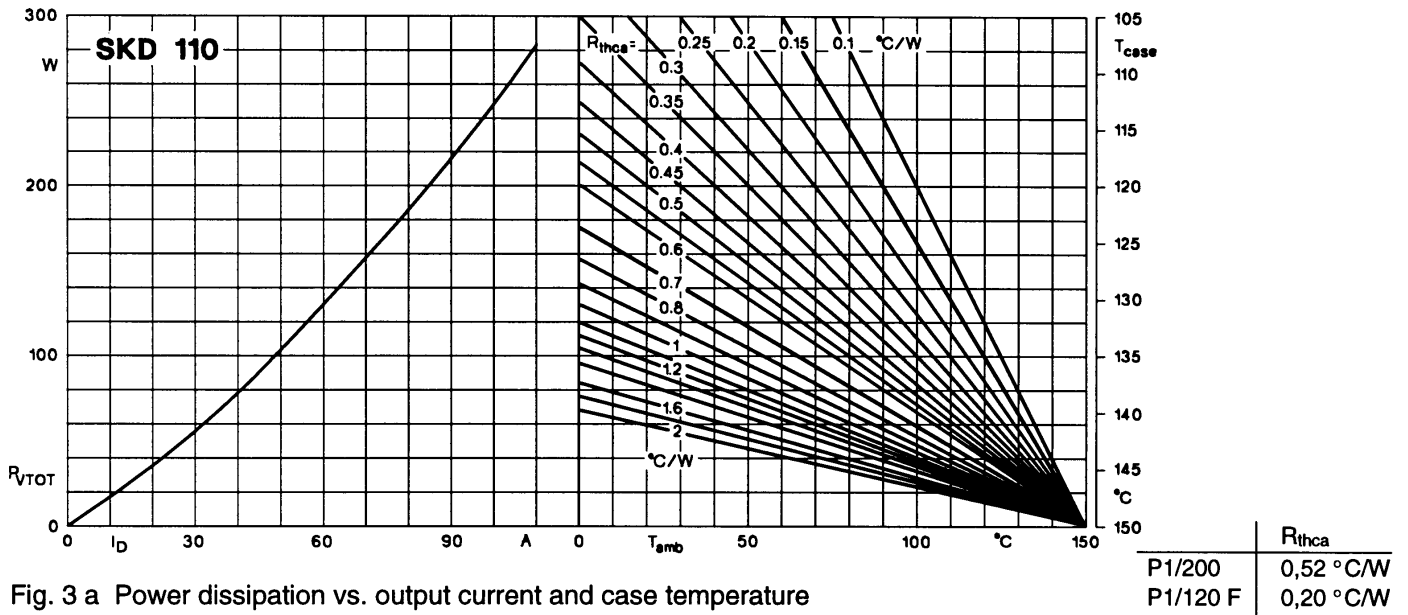

Fig. 3 a Power dissipation vs. output current and case temperature

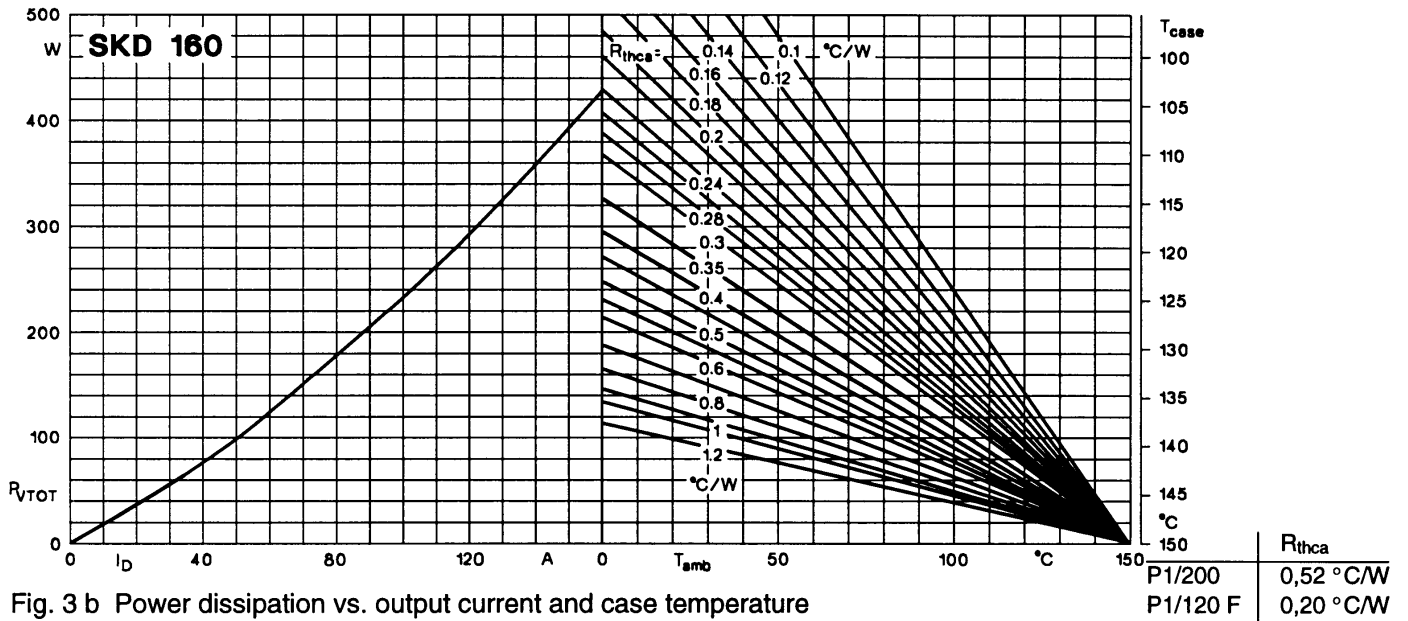

Fig. 3 b Power dissipation vs. output current and case temperature

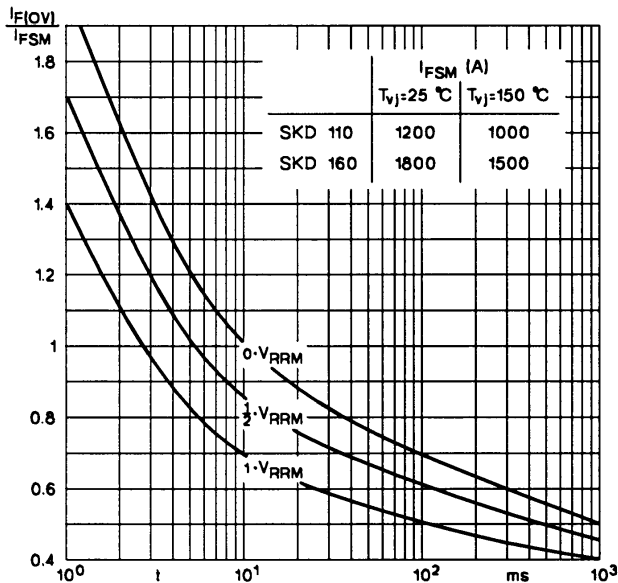

Fig. 5 Surge overload current vs. time

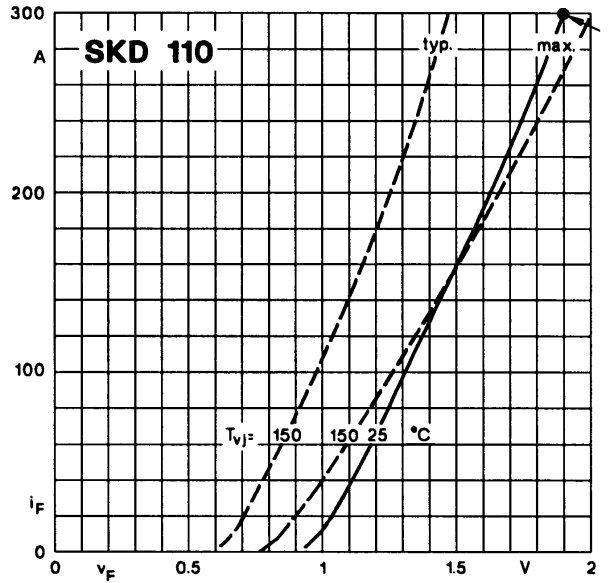

Fig. 9 a Forward characteristics of a single diode

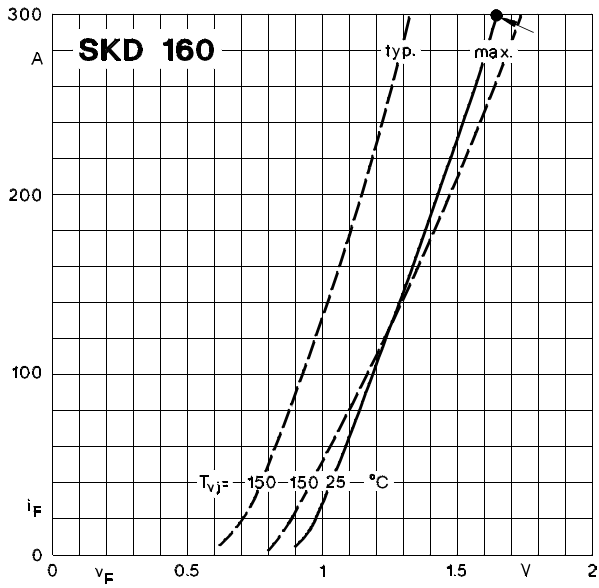

Fig. 9 b Forward characteristics of a single diode

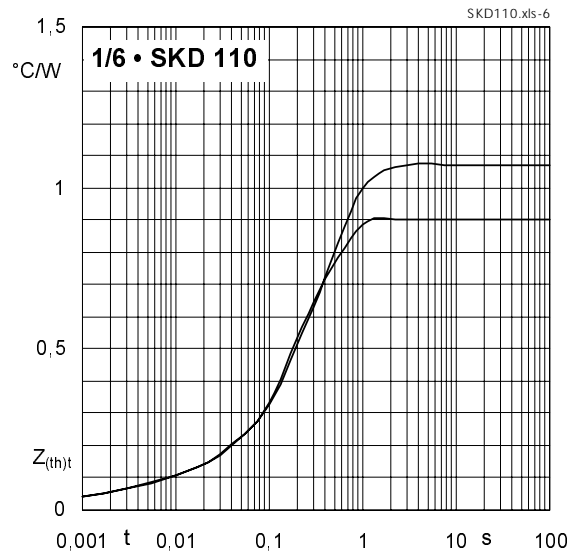

Fig. 12 a Transient thermal impedance vs. time

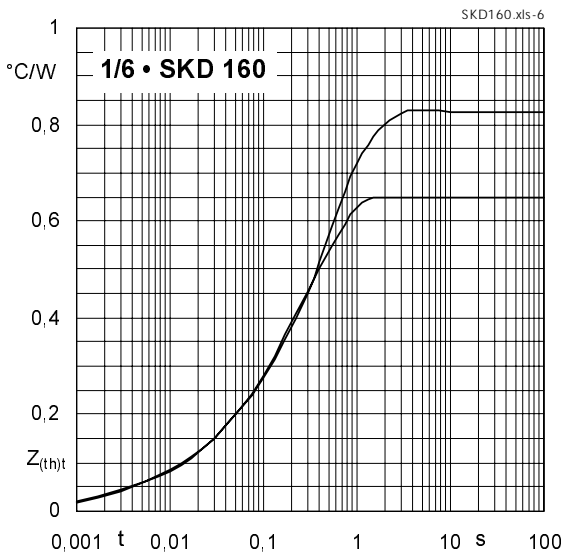
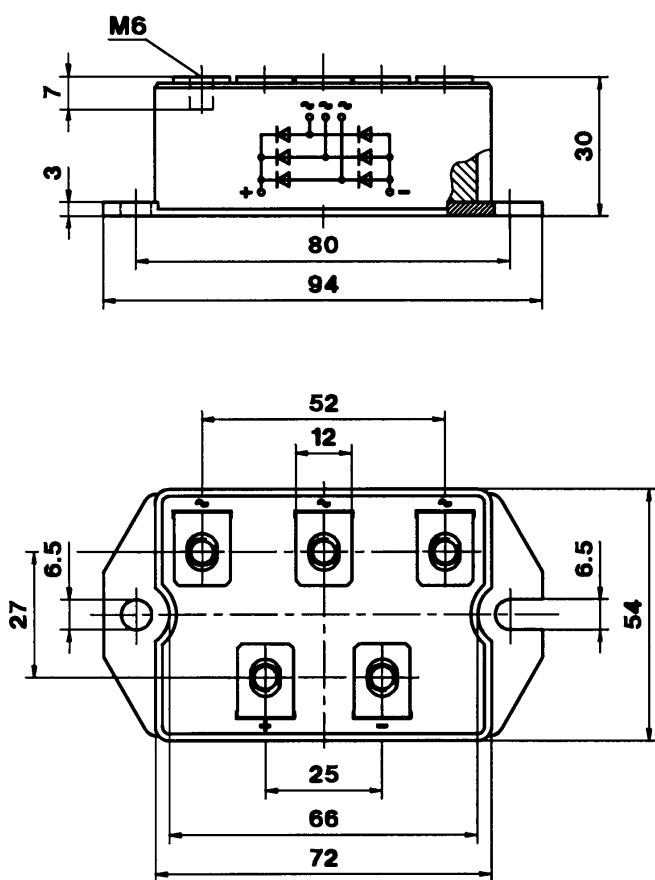

Fig. 12 b Transient thermal impedance vs. time

SKD 110
SKD 160

SEMIPONT® 4

Case G 37



Dimensions in mm